

# ROOF 46300 SURFACE

<b>PROJECT</b> PROJET
<b>SPEC TYPE</b>
<b>NOTES</b>

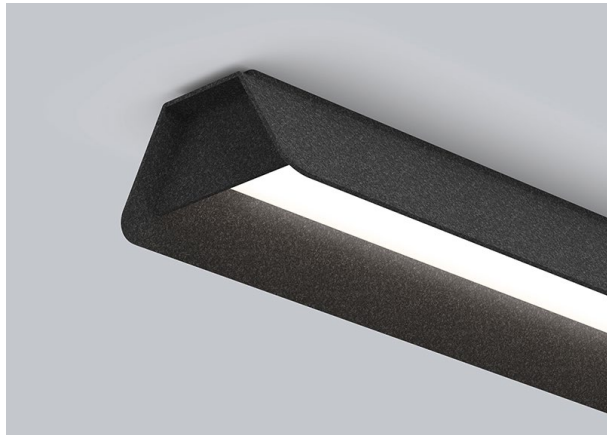

## SHADE FINISH FINI ABAT-JOUR



ADDITIONAL PREMIUM COLORS AVAILABLE – SEE ACOUSTIC MATERIAL COLOR OPTIONS PAGE

## MOUNTING OPTIONS OPTIONS DE MONTAGE

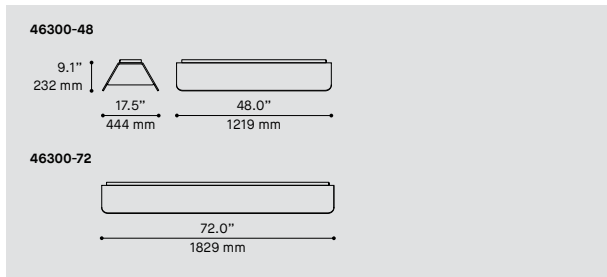

ORDERING SPECIFICATION	SPÉCIFICATION DE COMMANDE	CODE			
<b>MODEL</b> MODÈLE					
46300-48	ROOF SURFACE 48"				
46300-72	ROOF SURFACE 72"				
<b>LIGHT SOURCE</b> SOURCE LUMINEUSE		<b>REG</b>			
LED REG	REGULAR OUTPUT				
<b>COLOR TEMPERATURE</b> TEMPÉRATURE DE COULEUR					
27	2700K				
30	3000K				
35	3500K				
40*	4000K				
* LONGER LEAD TIME MAY APPLY, PLEASE CONTACT YOUR EUREKA REPRESENTATIVE					
<b>COLOR RENDERING INDEX (CRI)</b> INDICE DE RENDU DE COULEUR (IRC)		<b>90</b>			
90	90+ CRI				
<b>VOLTAGE</b> VOLTAGE					
120V	120 VOLT				
277V	277 VOLT				
<b>CONTROL OPTION</b> OPTION DE CONTRÔLE					
DV	0-10V DIMMING (120V-227V)				
DP	PHASE DIMMING (120V ONLY)				
NLTAIR2*	NLIGHT AIR CONTROL GEN 2				
NLIGHT*	NLIGHT WIRED CONTROL				
* NLIGHT INTEGRATION REQUIRES A REMOTE POWER PACK (39NLA A FOR NLTAIR2 OR 39NLWA FOR NLIGHT)					
* DUAL DIMMING NOT AVAILABLE WITH NLIGHT OPTIONS					
* FOR EMERGENCY BATTERY WITH NLIGHT OPTIONS, PLEASE CONTACT YOUR EUREKA REPRESENTATIVE					
REFER TO NLIGHT GUIDE AND INSTALLATION SHEET FOR ALL REQUIREMENTS.					
<b>EMERGENCY BATTERY</b> BATTERIE D'URGENCE					
FOR 120-277V ONLY. EM DRIVER BOX INCLUDED, INSTALLED REMOTELY. SEE EM GUIDE FOR DETAILS.					
EMB*	EMERGENCY BATTERY FOR REMOTE BOX				
*3981E ACCESSORY IS REQUIRED FOR THIS OPTION					
<b>SHADE FINISH</b> FINI ABAT-JOUR					
ABF	AZURE BLUE FELT	CHF	CHARCOAL GREY FELT	REF	RED FELT
BBF	BASIC BLACK FELT	NBF	NAVY BLUE FELT	SGF	SILVER GREY FELT
BOF	BLOOD ORANGE FELT	OBF	OCEAN BLUE FELT	TGF	TITANIUM GRAY FELT
BTF	BATTLESHIP GRAY FELT	PGF	PEAR GREEN FELT	ZFF	ZINFANDEL FELT
PREMIUM*	PLEASE SPECIFY PREMIUM COLOR CODE – SEE ACOUSTIC MATERIAL COLOR OPTIONS PAGE				
* LONGER LEAD TIME MAY APPLY, PLEASE CONTACT YOUR EUREKA REPRESENTATIVE					
<b>ENDCAP FINISH</b> FINI EMBOUT					
ABF	AZURE BLUE FELT	CHF	CHARCOAL GREY FELT	REF	RED FELT
BBF	BASIC BLACK FELT	NBF	NAVY BLUE FELT	SGF	SILVER GREY FELT
BOF	BLOOD ORANGE FELT	OBF	OCEAN BLUE FELT	TGF	TITANIUM GRAY FELT
BTF	BATTLESHIP GRAY FELT	PGF	PEAR GREEN FELT	ZFF	ZINFANDEL FELT
PREMIUM*	PLEASE SPECIFY PREMIUM COLOR CODE – SEE ACOUSTIC MATERIAL COLOR OPTIONS PAGE				
* LONGER LEAD TIME MAY APPLY, PLEASE CONTACT YOUR EUREKA REPRESENTATIVE					
<b>DIFFUSER FINISH</b> FINI DIFFUSEUR					<b>WH</b>
WH	WHITE				
<b>ACCESSORY</b> ACCESSOIRE					
ALL ACCESSORIES ARE AVAILABLE FOR ADVANCE SHIPPING					
39NLAA*	NLIGHT AIR GEN 2 REMOTE POWER PACK				
39NLWA*	NLIGHT WIRED REMOTE POWER PACK				
<b>ACCESSORY EMERGENCY BATTERY</b> ACCESSOIRE BATTERIE D'URGENCE					
3981EA	ELECTRICAL BOX FOR EMB EMERGENCY BATTERY				

## PRODUCT CHARACTERISTICS CARACTÉRISTIQUES DU PRODUIT



# Acoustic Material Color Options for Roof

## Standard colors



**ABF**  
Azure Blue

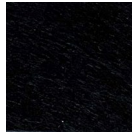

**BBF**  
Basic Black



**BOF**  
Blood Orange

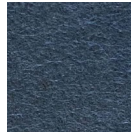

**BTF**  
Battleship Gray



**CHF**  
Charcoal

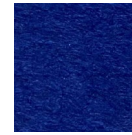

**NBF**  
Navy Blue



**OBF**  
Ocean Blue

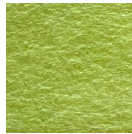

**PGF**  
Pear Green

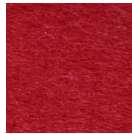

**REF**  
Red



**SGF**  
Silver Gray



**TGF**  
Titanium Gray



**ZFF**  
Zinfandel

## Premium colors



**BKF**  
Bark Brown



**DBF**  
Denim Blue

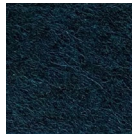

**DTF**  
Deep Teal Green

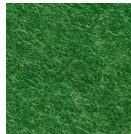

**GGF**  
Green Grass



**LGF**  
Lime Green



**MGF**  
Moss Green



**OAF**  
Oak Brown



**PBF**  
Peanut Brown



**PNF**  
Pinot Noir

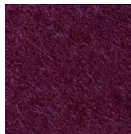

**PPF**  
Plum Purple

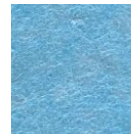

**SBF**  
Sky Blue



**TPF**  
Tulip Purple

— Premium colors carry extended lead times. Additional fees may apply for expedited lead times. Please consult factory.  
— Due to the dye process, colors may vary slightly from batch to batch.

# Cable Color Options for Roof

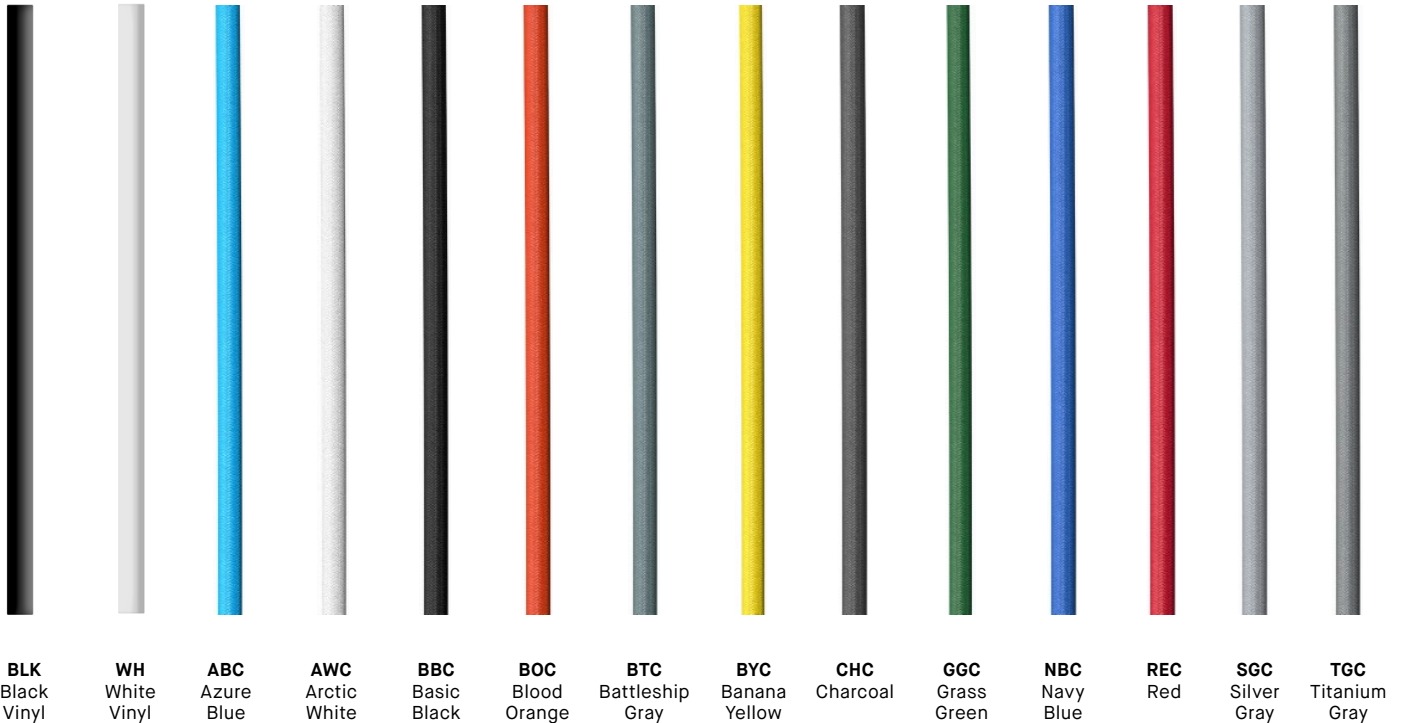

The cable has a  $\varnothing 0.265$ in (direct) or  $\varnothing 0.375$ in (direct+indirect) and is covered with a decorative braided sleeve.

IF YOU ARE LOOKING FOR ANOTHER COLOR, OUR TEAM IS HERE TO HELP MAKE YOUR VISION COME TRUE.

**CONTACT US**

- Longer lead time may apply.
- Colors shown for visual reference only.
- Due to the dye process, colors may vary slightly from batch to batch.
- Consult your sales representative or factory to get a sample.

# ROOF 48" / 72"

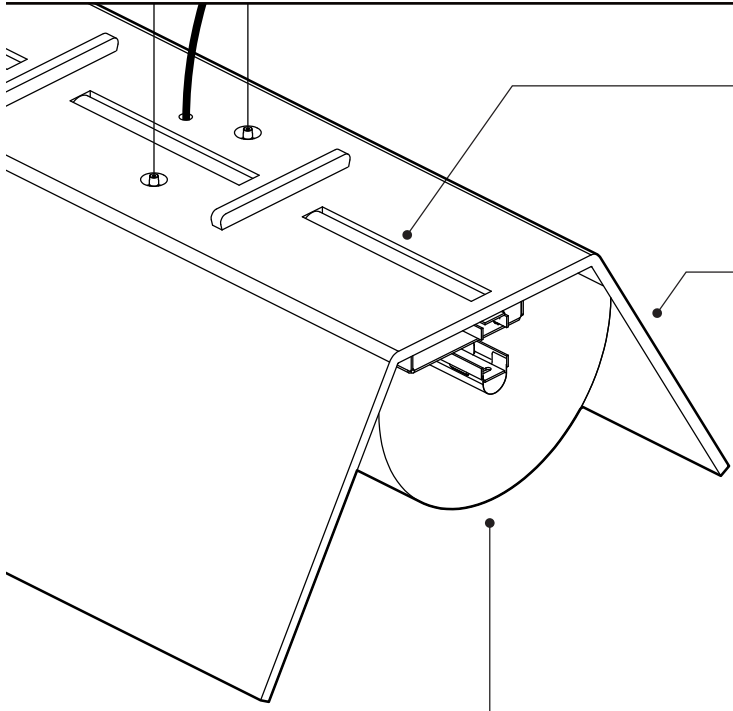

**INDIRECT OPTION**  
Roof is offered with an optional indirect light source, which can be controlled independently. We recommend a minimum height of 12" from the ceiling for diffused indirect light.

**SOFT TOUCH**  
The felt shell, made from recycled PET, adds an aspect of comfort thanks to its delicate feel and helps showcase the warmth of the fixture. Available in 24 colors.

CLASS A FIRE RATING  
ASTM E84-17 STANDARD

**NOISE REDUCTION**  
The material improves the acoustic properties of spaces which necessitate sound absorption.

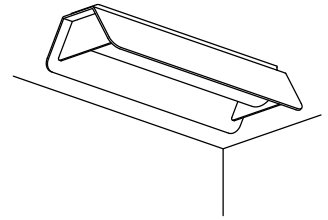

**SURFACE MOUNT**  
A ceiling mount version is available. This configuration includes a small felt trim, which conceals the installation hardware.

**COMFORTABLE ILLUMINATION**  
A large diffused surface, made from a highly efficient optical film, delivers a uniform and glare-free illumination.

**ATTACH & EXTEND**  
Combine multiple segments (4' and 6') to create a large variety of lengths. Contact your Eureka representative for custom length inquiries.  
\*Not offered in surface mount.

A single power drop is required, since the drivers are integrated within each fixture.

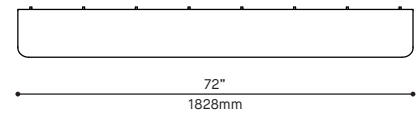
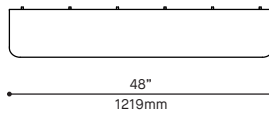
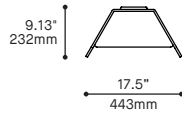
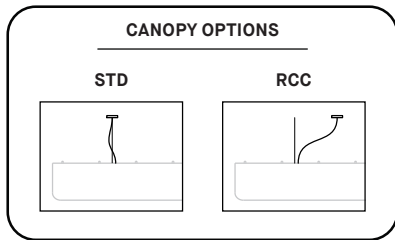
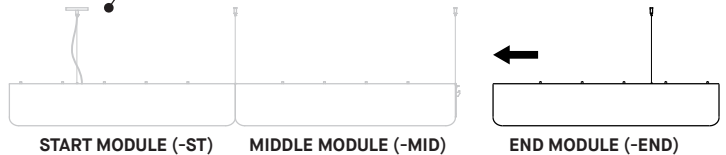

PRODUCT SPECIFICATION	4' DIRECT	6' DIRECT	4' INDIRECT	4' INDIRECT		6' INDIRECT		
	REG	REG	REG	REG (ST/END)	REG (MID)	REG	REG (ST/END)	REG (MID)
<b>PERFORMANCE</b>								
SYSTEM WATTAGE	32W	51W	26W	21W	16W	39W	33W	28W
DELIVERED LUMENS (4000K)	2109 LM	3398 LM	1836 LM	1468 LM	1102 LM	2761 LM	2366 LM	1971 LM
<b>OTHER INFORMATION</b>								
WEIGHT	8LBS / 3.6KG	12LBS / 5.5KG	8LBS / 3.6KG			12LBS / 5.5KG		
L70 (LUMEN MAINTENANCE)	60,000 HRS	60,000 HRS	60,000 HRS			60,000 HRS		
<b>WELL/LEED STANDARD REQUIREMENTS</b>								
MAX. LUMINANCE 45°-90° OF NADIR	709 CD/M² (AT REG)	501 CD/M² (AT REG)	628 CD/M² (AT REG)			387 CD/M² (AT REG)		
LIGHT QUALITY	R9 > 50 (WITH 4000K)		R9 > 50 (WITH 4000K)			R9 > 50 (WITH 4000K)		
FLICKERING TOLERANCE	LOW FLICKER, COMPLIANT TO CALIFORNIA TITLE 24		LOW FLICKER, COMPLIANT TO CALIFORNIA TITLE 24			LOW FLICKER, COMPLIANT TO CALIFORNIA TITLE 24		

## EFFICACY MULTIPLIERS

CRI	CCT	FACTOR
90+	4000K	1.00
90+	3500K	0.97
90+	3000K	0.93
90+	2700K	0.89

## LIGHT DISTRIBUTION

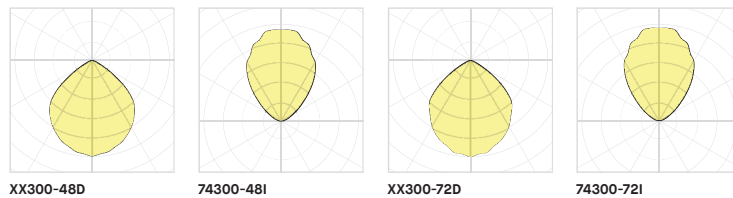

Visit our website for warranty terms and conditions.



## TECHNICAL DATA

# ROOF 48" / 72"

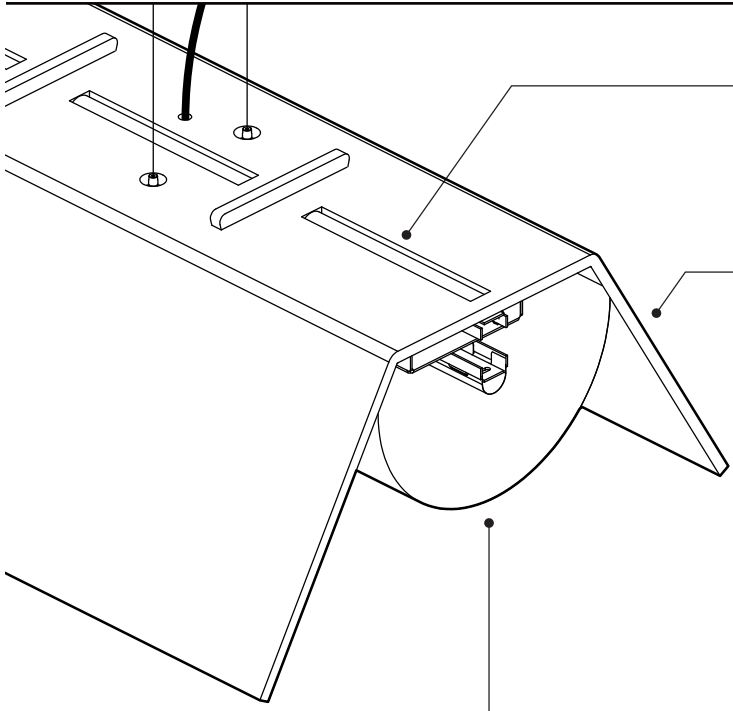

## OPTION INDIRECTE

Roof est offert avec une source lumineuse indirecte optionnelle qui peut être contrôlée indépendamment. Nous recommandons une hauteur minimale de 12" du plafond pour une lumière indirecte diffuse.

## TOUCHE CHALEUREUSE

L'abat-jour, fait de PET recyclé, ajoute un élément de confort grâce à sa surface feutrée et met en valeur l'aspect chaleureux du luminaire. Disponible en 24 couleurs.

CLASS A FIRE RATING  
ASTM E84-17 STANDARD



## REDUCTION DU BRUIT

Grâce à ses propriétés de réduction du bruit, le matériel permet d'améliorer l'acoustique d'une pièce.

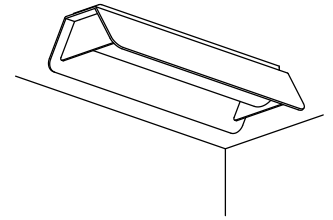

## MONTAGE SURFACE

Une version plafonnier est disponible. Cette configuration inclut une petite bordure de feutre, qui cache le mécanisme d'installation.

## ILLUMINATION AGRÉABLE

Une grande surface de diffusion, fait d'un film optique de haute efficacité, distribue une illumination uniforme et sans éblouissement.

## COMBINER POUR ALLONGER

Combinez plusieurs segments (4' et 6') bout-à-bout pour générer une grande variété de longueurs. Contactez votre représentant Eureka pour toute demande de longueur personnalisée.  
\*Non-disponible en version surface.

Un seul câble d'alimentation est requis, puisque les unités d'alimentation sont intégrées dans chaque luminaire.

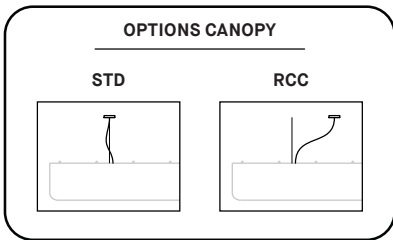
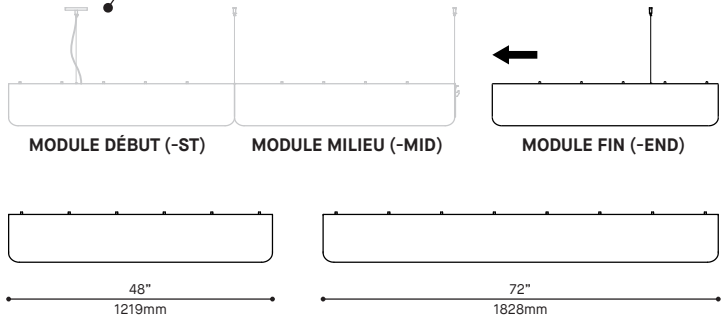

SPECIFICATION PRODUIT	4' DIRECT	6' DIRECT	4' INDIRECT	4' INDIRECT		6' INDIRECT		
PERFORMANCE	REG	REG	REG	REG (EXT-ST/END)	REG (MID)	REG	REG (EXT-ST/END)	REG (MID)
PUISSANCE TOTALE	32W	51W	26W	21W	16W	39W	33W	28W
LUMENS RÉELS (4000K)	2109 LM	3398 LM	1836 LM	1468 LM	1102 LM	2761 LM	2366 LM	1971 LM
<b>AUTRES INFORMATIONS</b>								
POIDS	8LBS / 3.6KG	12LBS / 5.5KG	8LBS / 3.6KG				12LBS / 5.5KG	
L70 (MAINTENANCE DE LA LUMIÈRE)	60,000 H	60,000 H	60,000 H				60,000 H	
<b>CRITÈRES DE CERTIFICATION WELL/LEED</b>								
MAX. LUMINANCE 45°-90° NADIR	709 CD/M² (EN REG)	501 CD/M² (EN REG)	628 CD/M² (EN REG)				387 CD/M² (EN REG)	
QUALITÉ DE LA LUMIÈRE	R9 > 50 (EN 4000K)	R9 > 50 (EN 4000K)	R9 > 50 (EN 4000K)				R9 > 50 (EN 4000K)	
TOLÉRANCE DE CLIGNOTEMENTS	PEU DE CLIGNOTEMENT (CONFORME À CALIFORNIA TITLE 24)						PEU DE CLIGNOTEMENT (CONFORME À CALIFORNIA TITLE 24)	

## FACTEUR D'EFFICACITÉ

IRC	CCT	FACTEUR
90+	4000K	1.00
90+	3500K	0.97
90+	3000K	0.93
90+	2700K	0.89

## DISTRIBUTION LUMINEUSE

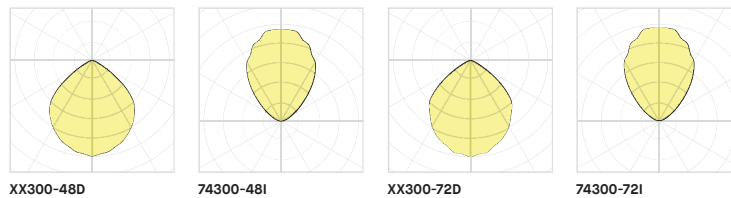

Visitez notre site Web pour les termes et conditions.



## DONNÉES TECHNIQUES